

DH-PTZ12230/12240-IRB -N

2Mp Full HD 30x/40x Network IR High-Speed Positioning System



Features

- Powerful 30x/40x optical zoom
- Support Triple-stream encoding
- Max 60fps@720P and 30fps@1080P resolution
- Defog, Wiper, DWDR, Ultra DNR, Ultra low bitrate, EIS, ROI, Day/Night(ICR), Auto iris, Auto focus
- Support Auto tracking and IVS
- Pan range: 360° endless, speed up to 160°/s
- Up to 300 Presets, 8 Tour, 5 Pattern, 5 Auto scan
- Support intelligent 3D positioning
- IR Distance up to 300m, IP66
- Multiple network monitoring: Web viewer, CMS(DSS/PSS) & DMSS

DH-PTZ12230/12240-IRB -N

Technical Specifications

Model	DH-PTZ12230-IRB-N	DH-PTZ12240-IRB-N
Camera		
Image Sensor	1/2.8" Exmor CMOS	
Effective Pixels	1944(H) x 1092(V), 2 Megapixels	
Scanning System	Progressive	
Electronic Shutter Speed	1/1 ~ 1/30,000s	
Min. Illumination	Color: 0.05Lux@F1.6, B/W: 0.005Lux@F1.6, 0Lux (IR on)	
S/N Ratio	More than 55dB	
Video Output	BNC(1.0Vp-p/75Ω), PAL / NTSC	
Camera Features		
Day/Night	Auto(ICR) / Color / B/W	
Backlight Compensation	BLC / HLC / DWDR (Digital WDR)	
White Balance	Auto, ATW, Indoor, Outdoor, Manual	
Gain Control	Auto / Manual	
Noise Reduction	Ultra DNR (2D/3D)	
Privacy Masking	Up to 24 areas	
Digital Zoom	16x	
Defog	On / Off	
ROI	Support	
Wiper	Support	
Lens		
Focal Length	4.3mm ~ 129mm (30x Optical zoom)	7.9mm ~ 316mm (40x Optical zoom)
Max Aperture	F1.6 ~ F5.0	F1.6 ~ F6.1
Focus Control	Auto / Manual	
Angle of View	H: 65.1° ~ 2.34°	H: 41.5° ~ 1.1°
Close Focus Distance	100mm ~ 1000mm	
PTZ		
Pan/Tilt Range	Pan: 0° ~ 360° endless; Tilt: -90° ~ 45°	
Manual Control Speed	Pan: 0.1° ~160° /s; Tilt: 0.1° ~60° /s	
Preset Speed	Pan: 0.1° ~160° /s; Tilt: 0.1° ~60° /s	
Preset	300	
PTZ Mode	5 Pattern, 8 Tour, Auto Pan, Auto Scan	
Positioning Accuracy	±0.1°	
Speed Setup	Human-oriented focal length/ speed adaptation	
Power up Action	Auto restore to previous PTZ and lens status after power failure	
Idle Motion	Activate Preset/ Pan/ Scan/ Tour/ Pattern if there is no command in the specified period	
Time Task	Auto activation of Preset/ Pan/ Scan/ Tour/ Pattern by preset-time	

DH-PTZ12230/12240-IRB -N

Protocol	DH-SD, Pelco-P/D (Auto recognition)	
IR Distance	300m	
Video		
Compression	H.264 / MJPEG	
Resolution	1080P(1920×1080) / 720P(1280×720) / D1(704×576/704×480) / CIF (352×288/352×240)	
Frame Rate	Main Stream	1080P (1 ~ 25/30fps) / 720P(1~50/60fps)
	Sub Stream1	D1/CIF(1 ~ 25/30fps)
	Sub Stream2	720P/D1/CIF(1 ~ 25/30fps)
Bit Rate	H.264: 56K ~ 8192Kbps, MJPEG: 56K ~ 20480Kbps	
Audio		
Compression	G.711a / G.711u(32kbps)/ PCM(128kbps)	
Interface	1/1 channel In/Out	
Intelligent Function		
Auto Tracking	Single-scene, multiple-scene, panorama-scene	
IVS	Tripwire, Cross Warning Zone, Perimeter Protection, Loitering Detection, Abandoned Object Detection, Missing Object Detection, Illegal Parking, Fast Moving and etc.	
Tracking Trigger Mode	Manual / Auto (alarm triggered)	
Tracking Trigger Event	Targeting, Zoom, Tracking, Recording, Snapshot, Alarm and etc.	
Network		
Ethernet	RJ-45 (10/100Base-T)	
Protocol	IPv4/ IPv6, HTTP, HTTPS, SSL, TCP/IP, UDP, UPnP, ICMP, IGMP, SNMP, RTSP, RTP, SMTP, NTP, DHCP, DNS, PPPOE, DDNS, FTP, IP Filter, QoS, Bonjour, 802.1x	
Compatibility	ONVIF PSIA CGI	
Max. User Access	20 users	
Smart Phone	iPhone, iPad, Android, Windows Phone	
Auxiliary Interface		
Memory Slot	Micro SD, Max 64GB	
RS485	1 port	
Alarm	7/2 channel In/Out	
General		
Power Supply	AC 24V/5A	
Power Consumption	≤100W	
Working Environment	-40°C ~ 70°C / Less than 90% RH	
Ingress Protection	IP66, All-metal aluminum alloy, 6000V anti-lightning surge	
Dimensions	391(mm) x 203 (mm) x 472 (mm)	
Weight	10.5Kg	

DH-PTZ12230/12240-IRB -N

Dimensions (mm)

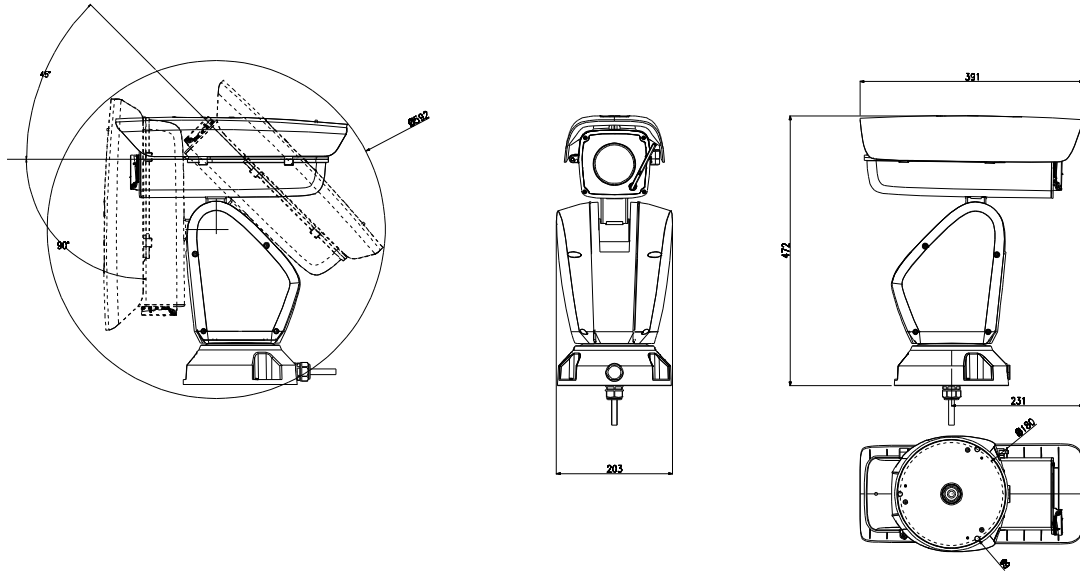

Dahua Technology Co., Ltd.

1199 BinAn Road, Binjiang District, Hangzhou, China

Tel: +86-571-87688883

Fax: +86-571-87688815

Email: overseas@dahuatech.com

www.dahuasecurity.com

*Design and specifications are subject to change without notice.

© 2014 Dahua Technology