



Biometric  
Solutions

Office Security



communication

Technology meets art



Latest Algorithm



# L7000-U Biometric Fingerprint Lock



## User Manual

Version 1.1  
Date: June 2012

# Table of contents

<b>1</b>	<b>Instructions</b>	<b>3</b>
1.1	Introduction to L7000 . . . . .	.3
1.2	List of Installation Accessories. . . . .	.3
1.3	Installation Requirements . . . . .	.4
1.4	Battery Backup. . . . .	.5
1.5	Front and Rear View . . . . .	.6
1.6	Precautions . . . . .	.7
1.7	User Privileges . . . . .	.7
1.8	Set Time. . . . .	.7
<b>2</b>	<b>Enrolment and Verification</b>	<b>8</b>
2.1	Enrol an Administrator . . . . .	.8
2.1.1	Enrol a Fingerprint . . . . .	.9
2.1.2	Enrol a Password . . . . .	10
2.2	Enrol a User . . . . .	11
2.3	Backup Enrolment . . . . .	11
2.4	Set User Verification and NO Status . . . . .	12
2.5	Delete User Data . . . . .	12
<b>3</b>	<b>Lock Function Information and Settings</b>	<b>13</b>
3.1	Operation Settings . . . . .	13
3.1.1	Operate Alarm Setting . . . . .	14
3.1.2	Illegal Times . . . . .	14
3.1.3	Lock Settings . . . . .	15
3.1.4	Verify Mode Setting . . . . .	15
3.1.5	Normal Open Setting . . . . .	15
3.2	Language Settings . . . . .	16
3.3	Advanced Settings . . . . .	16
3.4	Browse System Information. . . . .	16
3.5	Browse Logs . . . . .	17
3.6	Using USB . . . . .	17
<b>4</b>	<b>Other Functions</b>	<b>18</b>
4.1	Routine Operation Indications . . . . .	18
4.2	Administrator Loss Prevention. . . . .	19
4.3	Battery Low Voltage . . . . .	19
4.4	Auto Program Exit / Power Off . . . . .	19
4.5	Unlock with Emergency Key . . . . .	20
<b>5</b>	<b>Appendix</b>	<b>19</b>
5.1	Technical Specifications . . . . .	19

# 1. Instructions

## 1.1 Introduction to L7000

- By leveraging the perfect combination of biometrics and cryptography, our fingerprint locks ensure double security through the fingerprint + password unlocking feature.
- The state-of-the-art Organic LED (OLED) display affords crisp bright readouts and makes our fingerprint locks intuitive and easy to use. You can simply use our fingerprint locks with ease after following the operation instructions for once.
- Support setting of classified privileges for super administrators, administrators and ordinary users.
- Support deletion of all or the specified registration data.
- Support firmware upgrade and uploading/downloading of user information and locking records through a USB pen drive.
- Support offline view of locking records.
- Support accurate display of time and date with annual deviation less than two-minutes.
- Support a temporary connection with back-up batteries.
- You can set the fingerprint locks to be in the Normally Open (NO) state in special cases.
- Support display of the battery charge level and generation of low-pressure alarms.
- Feature an electric clutch handle design which helps effectively prevent the fingerprint lock failure caused by damage to the internal structure as a result of the forced destruction of the handle.
- Single latch lock (support both 60mm and 70mm locks) of American standard supports deadbolt lock either.
- The max user capacity is 500 fingerprints. The max unlocking record is 30000 logs.
- Unlock mode: fingerprint, password, mechanical key.

## 1.2 List of Installation Accessories

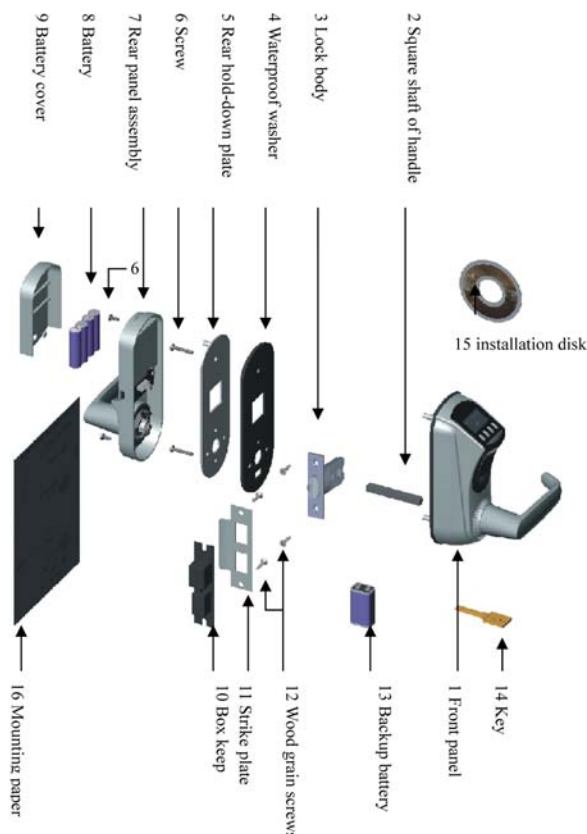

## Summary

\* Ensure to be familiar with all the components before installation

\* Do not install in direct sunlight or bright light

\* 0–50°C for optimal performance

SN	Name	Quantity	Unit	Remarks
01	Front panel assembly	1	Set	
02	Square shaft of handle	2	PCS	One need to select base on the door thickness
03	Lock body	1	Set	Single latch lock
04	Waterproof washer	2	PCS	Including the one on the front panel assembly
05	Rear hold-down plate	1	PCS	
06	Screw	6	PCS	Two of screws need to select base on the door thickness
07	Rear panel assembly	1	Set	
08	Batteries	4	PCS	Four pieces of alkaline AA batteries
09	Battery cover	1	PCS	
10	Box keep	1	PCS	
11	Strike plate	1	Set	
12	Wood grain screws	4	PCS	
13	Backup battery	1	PCS	9V
14	Key	2	PCS	
15	Installation disk	1	PCS	
16	Mounting paper	1	PCS	

### 1.3 Installation Requirements

- The fingerprint lock is applicable to doors of 35–50 mm in thickness. Be sure to list your special requirements or remarks for fingerprint locks to be installed on doors in excess of 70 mm in thickness before placing an order.
- Before ordering or installation of single latch lock, please confirm the corresponding accessories.
- Single latch lock:



Unlock Directional Switch



1. Remove the screw of handle, then take off the handle and rotate 180°.



2. Reload the handle and fix it with screws.

\* Ensure environment before ordering units

\* Follow these steps for changing unlock direction

- Please confirm the door opening directions. Assume you are standing outside and facing a door and then there are four door opening directions: Left inward, left outward, right inward and right outward. Left inward/outward means the door swings inward/outward with hinges on the left; right inward/outward means the door swings inward/outward with hinges on the right, as shown in the following figure:

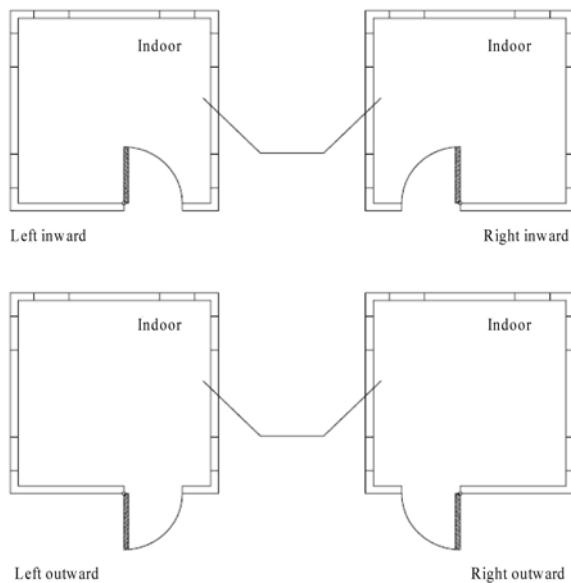

- Ensure the central point of the handle is about 1m above the floor.
- Ensure all the accessories installed on the right position.
- Please follow the animated instructions to install fingerprint locks.

#### Recommended Tools

You may need the following tools while following the instructions to install fingerprint locks:

- A ruler.
- A marker pen.
- A drilling tool.
- A cross screwdriver.

## 1.4 Battery Backup

The fingerprint lock supports temporary use of external DC power for fingerprint or password matching and unlocking, but when connected with an external battery, the fingerprint lock cannot provide such special functions as enrollment, deletion and setting, so as to prevent data loss as a result of power instability.

As shown in the figure below, connect a 9V battery to the two access points at the bottom of a fingerprint lock, regardless of polarities.



If you power off a fingerprint lock without closing the lock during the use of external power, the lock cylinder will not automatically return to its original position. That is, the fingerprint lock remains in NO state. To solve this problem, you can replace the battery and then verify to open the lock once to have the lock cylinder back position.

## Summary

\* Ensure correct installation

\* Take note of tools

\* Battery override to be able to do a biometric reading

\* NOT an administrator override

## 1.5 Front and Rear View

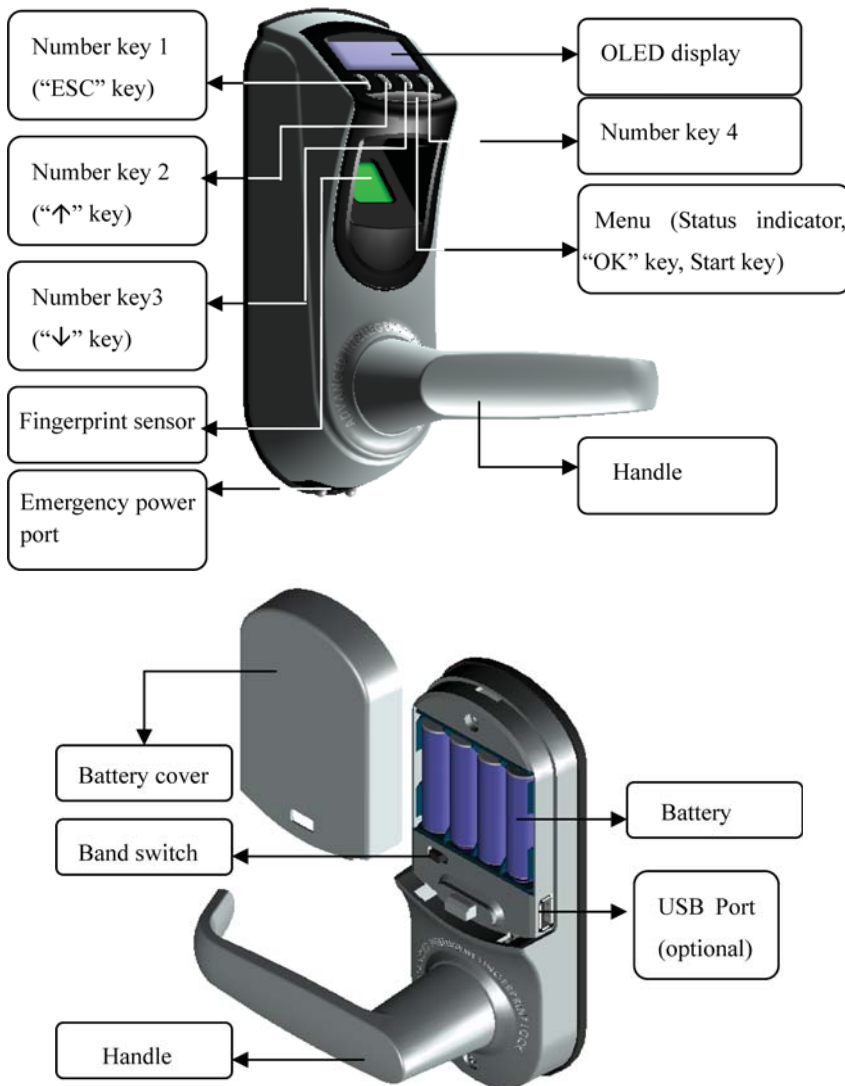

- **Number key 1:** Press this key to exit current operation, press and hold this key to power off the fingerprint lock. The number key "1" doubles as ESC key.
- **Number key 2:** This key is used to manually increase (when held this key, the display values will rapidly increase) the setup value or navigate among menu options. The number key "2" doubles as UP key.
- **Number key 3:** This key is used to manually decrease (when held this key, the display values will rapidly decrease) the setup value or navigate among menu options. The number key "3" doubles as DOWN key.
- **Menu key (Status indicator):** This key can be used to start the fingerprint lock; press and hold this key for three seconds on the initial interface to open the main menu; this key also doubles as the confirmation OK key. The green LED indicator blinks when the fingerprint lock operates properly and the red LED indicator is on for three seconds if an error occurs. The green LED indicator is on for three seconds when an operation succeeds.
- **Band switch:** If you cannot access the menu options due to the loss of administrators for some reason, proceed as follows: Press and hold the Menu key for three seconds to display the administrator verification, and then turn the Band switch at the rear of the lock to the left or right to open up the menu as a super administrator.
- **OLED display:** The black-and-white OLED display features white graphics or text against a black background.
- **Fingerprint sensor:** You can only collect or match fingerprints by pressing your finger(s) at the fingerprint sensor when the light in the fingerprint sensor window goes on; otherwise nothing happens when you press your finger(s) at the fingerprint sensor.

## Summary

\* Be familiar with the unit

\* Keys on the unit

**Note:** When you cannot power off the fingerprint lock due to the exception of program, press and hold the ESC key to power off and then restart the fingerprint lock. It is not recommended to power off the fingerprint lock by pressing and holding the ESC key when the fingerprint lock operates normally.

- [Emergency interfaces](#)

**Keyhole:** You can use a mechanical key for emergency door opening. **Temporary external power interface:** You can adopt an external back-up battery to open the lock in the event of unlocking failure due to insufficient power supply of the fingerprint lock.

- [USB interface](#)

The USB interface is used for firmware upgrade and uploading/downloading of user information and locking records through a USB pen drive.

## 1.6 Precautions

- We strongly recommend you to enroll at least one administrator after installing the fingerprint lock. You must at least enroll one administrator before enrolling ordinary users.
- Do not remove batteries when matching, enrolling or deleting fingerprints because the sudden power-down may result in data loss of fingerprint locks. Prior to removing batteries, make sure the fingerprint lock is not in working state.
- It is recommended to replace the fingerprint lock batteries at least once every six months to avoid damaging the circuit due to the battery leakage. Do not use batteries with poor quality.
- When installing a fingerprint lock, connect the plug to the socket properly. Improper connection may lead to fingerprint lock failure.

## 1.7 User Privileges

The user privileges are classified into three types: Super administrators, administrators and ordinary users.

- **Super administrators:** refer to users who have access to all system functions and modify all system settings.
- **Administrators:** refer to users who have access to all operations except performing advanced settings and enrolling super administrators.
- **Ordinary users:** refer to all users other than the super administrators and administrators. Ordinary users only have access to the fingerprint matching and unlocking functions.

## 1.8 Set Time

You need to set the correct date and time on first use of a fingerprint lock in the following steps:

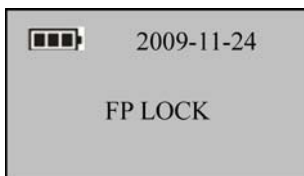

1) Power on the fingerprint lock by pressing the Start key to open up the initial interface, as shown in the figure on the left.

**Note:** The "BATTERY " icon on the initial interface is the battery icon indicating how much charge remains. On the top right corner of the initial interface, the display alternates between date and time every 5 seconds.

## Summary

\* Ensure to enrol administrator for security purposes

\* Ensure to use 4x new batteries together and do not mix with old batteries

\* Enrol correct people on correct levels to ensure security of the unit

\* Correct Date and Time are necessary before operating

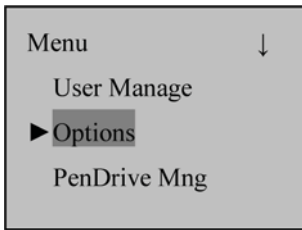

2) Press and hold the Menu key for three seconds to access the menu interface. Press DOWN to select "Options" and press MENU to display the setting interface.

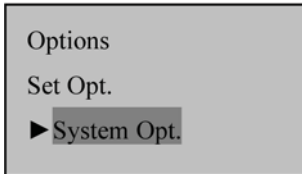

3) Press DOWN to select "System Opt." and then press MENU.

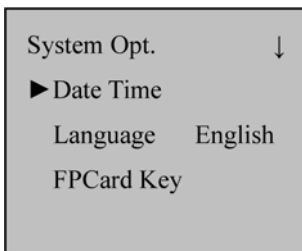

4) Press MENU to select "Date Time".

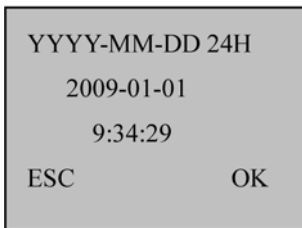

5) To modify date or time, press UP/DOWN to move the cursor to the desired option, and then press UP/DOWN again to enter correct date or time. Press MENU to save your settings.

## 2. Enrolment and Verification

### 2.1 Enrol an Administrator

If the fingerprint lock has no administrator, you must at least enroll one administrator before enrolling ordinary users. To enroll an administrator, proceed as follows:

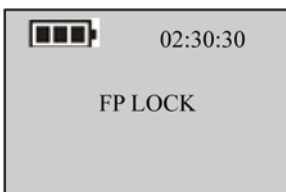

1) Power on the fingerprint lock by pressing the Start key to open up the initial interface. Press and hold the Menu key to display the menu interface.

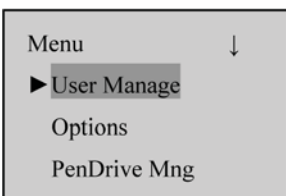

2) Press MENU to display the user management interface.

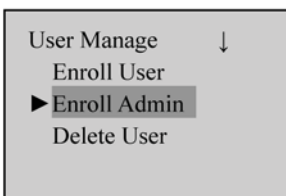

3) Press DOWN to select "Enroll Admin" and then press MENU.

\* Ensure to enrol an administrator on the unit before enrolling users



## 2.1.1 Enrol a Fingerprint

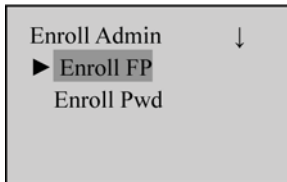

4) Press ▼ to select "Enroll FP" and then press MENU.

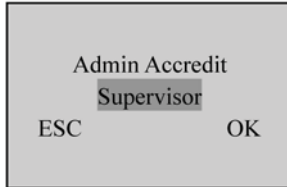

5) Press ▲/▼ to select "Admin Accredit", and then select "Supervisor" (Super administrator) or "Admin" (Administrator). Press MENU to confirm your selection.

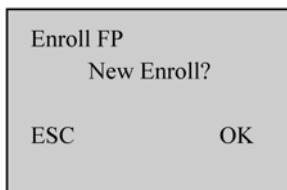

6) Press MENU to continue.

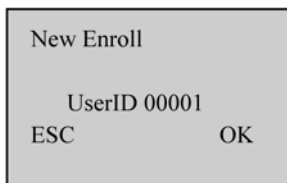

7) The system by default assigns unused user IDs from 00001 and you may also manually enter an unused user ID.



8) Press the same finger on the fingerprint sensor three consecutive times by adopting the proper finger placement mode. The system will prompt you to save the enrollment information after you enroll the fingerprint successfully. If enrollment fails, the system will prompt you to re-enroll your fingerprint.

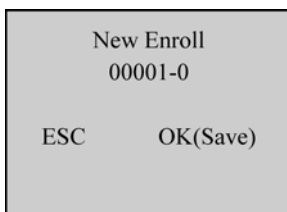

9) The system will prompt to save the enrollment information after enrollment successful. If the enrollment fails, the system will prompt if re-enroll fingerprint. The system returns to the "New Enroll" interface upon successful enrollment. You can continue or exit the fingerprint enrollment.

**Note:** The last digit in "00001-0" refers to the fingerprint count. "0" refers to the first fingerprint, "1" refers to the second fingerprint and so on and so forth.

## Summary

## 2.1.2 Enrol a Password

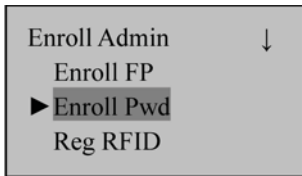

4) Press ▼ to select "Enroll Pwd" and then press MENU.

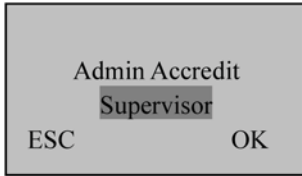

5) Press ▲/▼ to select "Admin Accredit", and then select "Supervisor" (Super administrator) or "Admin" (Administrator). Press MENU to confirm your selection.

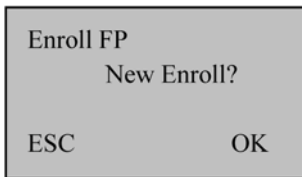

6) Press MENU to continue.

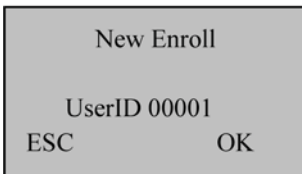

7) The system by default assigns unused user IDs from 00001 and you may also manually enter an unused user ID.

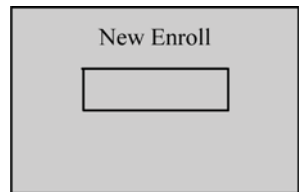

8) Input a password by pressing the number keys and press MENU to confirm your input.

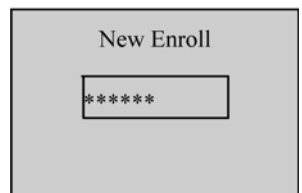

9) Input the password again by pressing the number keys and press MENU to confirm your input. Press MENU after successful password enrollment to return to the "New Enroll" interface.

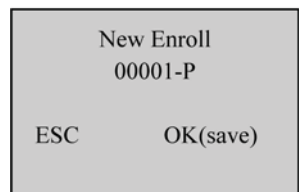

10) Press MENU to save the enrolled data and exit the password enrollment.

**Note:** A password consists of 6 to 10 digits. You can enroll only one password for each user ID and repeated passwords are allowed; otherwise, the system will display the prompt "Password Error".

## Summary

\* Password users can be enrolled if FP is unavailable

\* Take Note

## 2.2 Enrol a User

An administrator can enroll only ordinary users, with operation steps as follows:

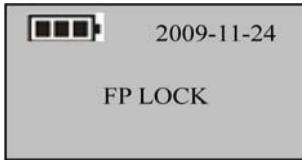

1) Power on the fingerprint lock by pressing the MENU key to open up the initial interface.

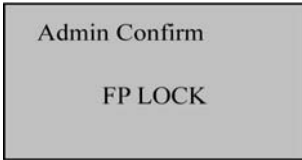

2) Press and hold the Menu key to access the menu options. The system will then prompt you for administrator confirmation. Enter the administrator password or match your fingerprint once. Skip to step 4 if verification succeeds; otherwise, proceed to step 3.



3) The system displays the prompt "Error Pwd." on the screen and return to the "Admin Affirm" interface for re-verification. The following menu interface is displayed upon successful verification.

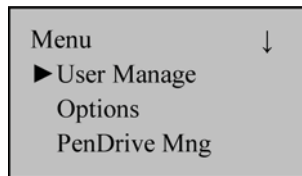

4) Press MENU to display the user management interface.

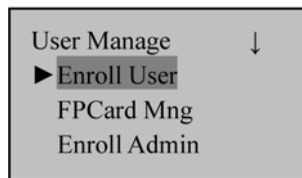

5) Press DOWN to select "Enroll User" and then press MENU.

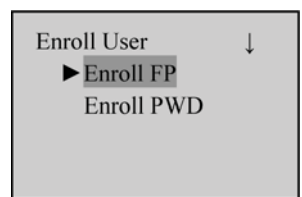

6) Enter the user enrollment interface

## 2.3 Backup Enrolment

On the "New Enroll?" interface, if you press ESC to cancel new enrollment, then the

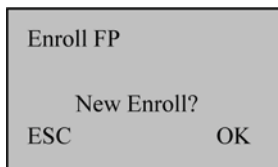

PRESS ESC

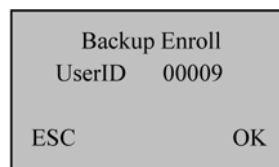

"Backup Enroll" interface will be displayed, as shown in the figure on the right. The backup enrollment steps are basically consistent with the new enrollment steps except that "Backup Enroll" instead of "New Enroll" is displayed on the top of the interface.

**Note:** 1. It is a wise choice to enroll fingerprints of at least two different fingers for regular users.

2. If you wish to modify the password after finishing password enrollment, you can replace the original password with the password entered in backup enrollment.

## Summary

\* Administrators need to enrol users

\* It is recommended to enrol more than one finger per user

## 2.4 Set User Verification and NO Status

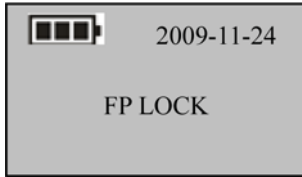

1) Press the Start key to display the initial interface. The fingerprint sensor is in active state.

2) Press your finger with fingerprint already enrolled or enter your password (press MENU after entering password.)

**Note:** You can only match fingerprints when the fingerprint lock is in non-NO state.



3) Your ID number will be displayed on the screen upon successful verification and then you can hear the unlocking sound. Rotate the handle of the fingerprint lock within 4 seconds to open the door. If the NO function is set to "YES" (See 3.1), the prompts as shown in step 4 and step 5 will be displayed upon successful verification; otherwise, no prompt will be displayed.

If fingerprint or password verification is unsuccessful, the system will display a prompt "Please press your finger again" or "Password error". The parameters "Illegal Cnt." and "Illegal Alarm" are set by the administrator. The system will generate an alarm after the illegal operations reach the specified value. For details, see 3.1.

**Note:** If the value of the parameter "Illegal Cnt." is larger than 6, the system will automatically power off if you fail to verify your fingerprint or password 6 consecutive times.

## 2.5 Delete User Data

**Warning:**

*It is prohibited to power off the fingerprint lock while deleting user data so as to prevent the program from accidentally deleting other data.*

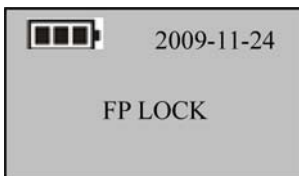

1) Press the start key to power on the fingerprint lock and then enter the initial interface.

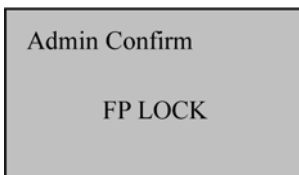

2) Enter the administrator password or fingerprint once. If the verification succeeds, jump to Step 4; otherwise, go to Step 3.



3) The system displays the prompt "Error Pwd." on the screen and returns to the "Admin Affirm" interface for re-verification. If you pass the verification, you can access the "Menu" interface.

## Summary

\* NO - Normal Open

\* Use NO if door is handling high volume traffic, to a less secure area.

\* Only administrators can perform these tasks

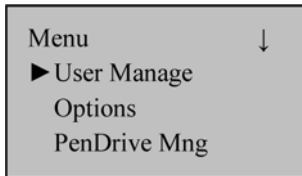

4) Press MENU to display the "User Manage" interface.

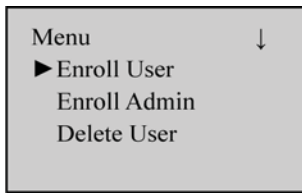

5) Press ▼ to select "Delete User", and press MENU.

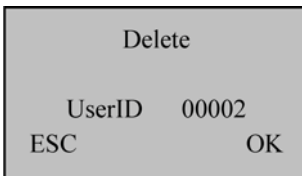

6) Press ▲/▼ to select the user ID that you want to delete and then press MENU to confirm your selection. If the user has enrolled his/her fingerprints,

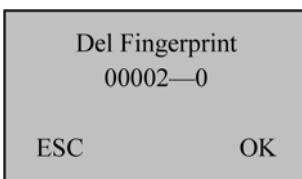

7) Press MENU to delete the fingerprints. If the user has enrolled a password,

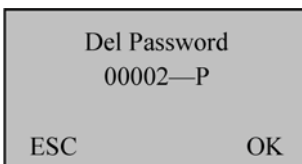

8) Press MENU to delete the password.

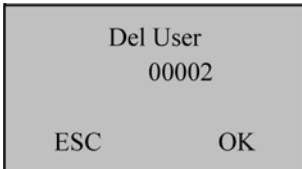

9) Confirm the deletion of this user. Press MENU to confirm the deletion, or press ESC to return to the "User Manage" interface.

10) After deleting the user data, you can restart the fingerprint lock and match the deleted fingerprints again to check whether the user data is deleted for sure.

**Note:** The Administrator (include super administrator) can only delete ordinary user. If you need to delete the administrator ID, please enter the "Adv Option" in "Options" menu, select "Clr admin pri", and return to "Delete user" option in user management menu to delete this user ID.

\* TAKE NOTE

### 3. Lock Function Information and Settings

#### 3.1 Operation Settings

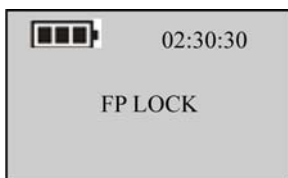

1) Press Menu and the device power on, enter the initial interface. Long press Menu to enter menu.

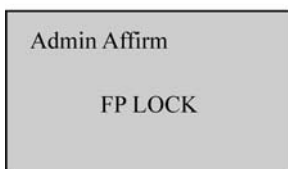

2) Input administrator password or press the administrator fingerprint.

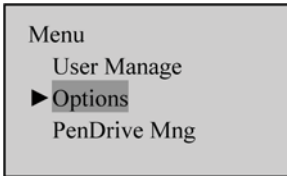

3) Press 3 to select "Options", another press Menu to enter the menu.

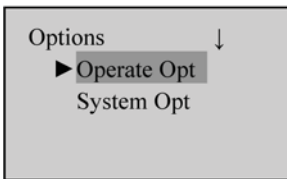

4) Select "Operate Opt", and press Menu to enter the menu.

Select "Options" RIGHT KEY "Set Opt." from the main menu to display the following information:

Set Opt.	
Illega Alarm	Yes
Illega Cnt.	10
Lock	5

Verify Mode	1
Normal Open	Yes
Card Only	No

### 3.1.1 Operate Alarm Setting

It is used to set if the operation failure trigger the alarm.

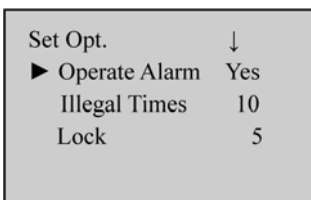

Operate the step 1), 2), 3), 4) in 3.1 Operation settings, enter the operation menu and select "Operate Alarm". Press Menu to enter the modify state, press 2/3 to select Yes/No, after modification, press Menu to save and quit.

### 3.1.2 Illegal Times

This parameter is used to set the consecutive operation failure count. An invalid operation alarm will be generated when the consecutive failure count exceeds the threshold.

**Note:** The failure count is cumulated when the fingerprint lock is started next time. If the number of cumulative failures exceeds the threshold, the fingerprint lock will generate an invalid operation alarm; otherwise, the failure count will no longer be accumulated after successful unlocking.

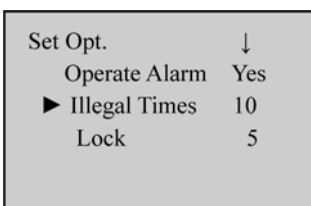

Operate the step 1), 2), 3), 4) in 3.1 Operation settings, enter the operation menu and select "Illegal Times". Press Menu to enter the modify state, press 2/3 to set the value (the value by default is 10, the permit range is 3~99), after modification, press Menu to save and quit.

If the number of cumulative failures exceeds the threshold, the fingerprint lock will automatically power off. After device restart the fingerprint lock will generate an invalid operation alarm of buzzer sound. About 30 seconds it will power off automatically.

### 3.1.3 Lock Settings

This parameter is used to set the duration from successful matching to unlocking.

**Note:** The unit of quantity and the maximum value of this parameter here are standard configurations. If you need larger parameter values, please consult our commercial representatives or pre-sales technical support engineers.

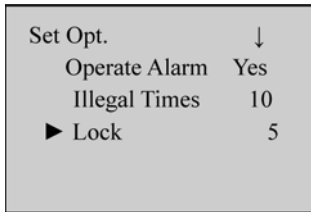

Operate the step 1), 2), 3), 4) in 3.1 Operation settings, enter the operation menu and select "Lock". Press Menu to enter the modify state, press 2/3 to set the value (the value by default is 5, the permit range is 3~15), after modification, press Menu to save and quit.

### 3.1.4 Verify Mode Setting

This parameter is used to set the duration from successful matching to unlocking.

**Note:** The unit of quantity and the maximum value of this parameter here are standard configurations. If you need larger parameter values, please consult our commercial representatives or pre-sales technical support engineers.

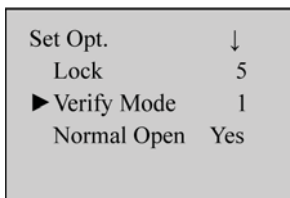

Operate the step 1), 2), 3), 4) in 3.1 Operation settings, enter the operation menu and select "Verify Mode". Press Menu to enter the modify state, press 2/3 to set the value. There are 3 optional values 0, 1, and 2 that represent different matching modes, and the default value is 1. Press Menu to save and quit.

- **Verify Mode 0:** Only the administrator can open the lock, while the unlocking function is disabled for ordinary users.
- **Verify Mode 1:** This is a default matching mode. Users can open the lock by successfully matching their fingerprints only once.
- **Verify Mode 2:** This is a dual verification mode. The administrator can open the lock by successfully matching his/her fingerprint only once, but an ordinary user has to pass the verification in any two matching modes by using the same ID.

### 3.1.5 Normal Open Setting

This parameter is used to set the duration from successful matching t

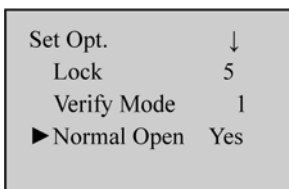

1) Operate the step 1), 2), 3), 4) in 3.1 Operation settings, enter the operation menu and select "Normal Open". Press Menu to enter the modify state, press 2/3 to select Yes/No, after modification, press Menu to save and quit

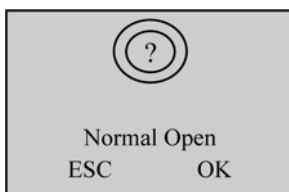

2) In the start interface verify the fingerprint (the finger press please refer to 1.3 Fingerprint Press Introduction) and unlock.

3) Prompt if you select NO state, and press Menu to save.

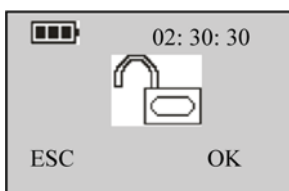

4) After successful setting, the screen display as left figure. That indicate the setting is success, and the buzzer sound 3 times for prompt.

5) To disable the NO function, power on the system and press Menu in the "Normal Open" interface. Then the system closes the lock and automatically powers off.

### 3.2 Language Settings

Select "Options" RIGHT KEY "System Opt." RIGHT KEY "Language" from the main menu to display the following information:

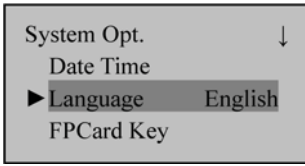

Press OK to display the Language interface, and press ▲/▼ to select a desired language. Press MENU to confirm your settings and then press ESC to exit System Opt. When the system prompts whether to save your settings, press MENU and your settings will take effect after system restart.

**Note:** Language selection is a non-standard function. If you need this function, please consult our commercial representatives or pre-sales technical support engineers.

### 3.3 Advanced Settings

**Note:** Only the super administrator has the right to perform advanced settings. Select "Options" RIGHT KEY "System Opt." RIGHT KEY "Adv Option" from the main menu to display the following information:

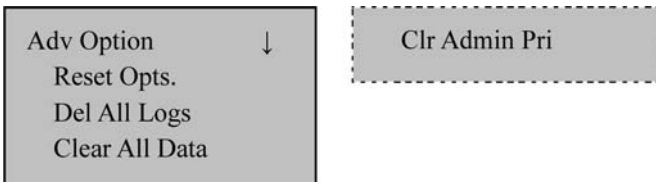

The options under "Adv Option" include: Reset Opts., Del All Logs, Clear All Data, and Clr Admin Pri. Select any one of these options and press OK to display the related setting interface. Press OK according to the prompt to confirm your settings and return to the Adv Option interface, or press ESC to exit current interface without performing any operation.

- **Reset Opts.:** This parameter is used to restore the fingerprint lock to factory defaults.
- **DelAll Logs:** This parameter is used to delete all the verification records from a memory chip.
- **ClearAll Data:** This parameter is used to delete all the enrolled fingerprint images, passwords and records.
- **Clr Admin Pri:** This parameter is used to change an administrator into an ordinary user. This function shall be used with caution. It is recommended to register at least one new administrator in time after clearing the priority of an administrator.

### 3.4 Browse System Information

Users can browse all the system information, including the enrolled fingerprint counts, enrolled user, and device information. Select "Sys Info" from the main menu, and press OK to proceed to the next step and display the following information:

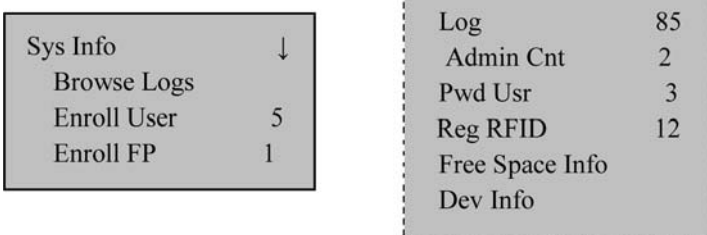

### Summary

\* Ensure corret language have been selected

\* TAKE NOTE

\* Keep attention to LOGS



Press ▲/▼ to select Free Space Info and then press OK to browse the following information:

Free Space Info	
FP Cnt	499
Log	29915
Reg RFID	488

**Note:** Only the fingerprint locks supporting ID cards are configured with the “Reg FPID” and “Free Space Info” options.

Press ▲/▼ to select Dev Info and then press OK to browse the following information:

Dev Info	↓	Serial Num Vendor Device Name Alg Version Firmware Ver
FPCnt(100)	5	
Log(10k)	3	
Manu Time		

### 3.5 Browse Logs

The fingerprint locks support the offline browsing of unlocking logs, which facilitates users to check whether there is any exceptional unlocking in time.

Select “Browse Logs” from the main menu to display the following information:

Browse Logs	
UserID	0001
ESC	OK

Press ▲/▼ to select a registered number that you want to browse logs and then press OK to confirm the log date and time:

	2--1	The first digit denotes the total number of records and the last one denotes current record.
PIN:	0001	
2009-04-05	14: 49	
ESC	OK	

### 3.6 Using USB

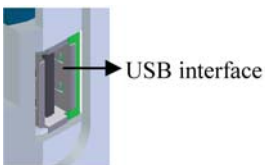

1) Insert a USB pen drive into the USB interface.

\* Ensure to test the USB device on the unit

?	
PenDrive Mng?	
ESC	OK

2) Select “PenDrive Mng” from the main menu and press OK. A prompt as shown below is displayed.

PenDrive Mng
DwnLoad AttLog
DwnLoad User
UpLoad User

3) Press OK in the prompt dialog box to display the following interface:

## 1. Download ATT Logs



1) Press ▲/▼ to select “Dwn AttLog” and then press OK. When download completes, the following interface is displayed:

2) Press ESC to return to the initial interface and then remove the USB pen drive. Now the USB pen drive stores two files: X\_attlog.dat (attendance logs) and X\_user (where “X” denotes that the device No. is X).

**Tip:** If the download succeeds, a prompt “Copy Data Suc” will pop up. If the system displays the prompt “Plug Pen Drive?”, please check whether the USB pen drive is plugged in properly.

## 2. Download User Data

User data downloading is similar to the downloading of attendance logs. Press ▲/▼ to select “DwnLoad User” from the “PenDrive Mng” menu. The files user.dat (user information) and template.dat (fingerprint template) will be concurrently downloaded to the USB pen drive.

## 3. Upload User Data

Press ▲/▼ to select “UpLoad User” from the “PenDrive Mng” menu and then press OK. The files user.dat (user information) and template.dat (fingerprint template) stored in the USB pen drive will be concurrently uploaded to the fingerprint lock.

**Tip:** If a user exits with the same ID in the fingerprint lock, the new upload will overwrite the existing user data; otherwise, the new user data will be directly added.

## 4. Upgrade Firmware

You can select “Upd Firmware” to upgrade the firmware of a fingerprint lock through the upgrade files in the USB pen drive.

**Note:** If you need firmware upgrade files, please contact our technical support engineers. Generally it is not recommended to upgrade the firmware.

**Tip:** Please do not perform invalid operations (for example, insert or remove the USB pen drive in a frequent manner or during upload/download) on the USB pen drive, because it may result in system instability. It is recommended to keep the door open during the use of the USB pen drive.

# 4. Other Functions

## 4.1 Routine Operation Indications

- **User operation success indication:** The buzzer sounds once and the green LED indicator is solid on for 3 seconds.
- **User operation failure indication:** The buzzer sounds short tone twice and the red LED indicator is solid on for 3 seconds.
- **Warning indication:** The buzzer sounds short tone five times intermittently.

## Summary

\* Upload can be used if a pre-enrolment have been done software with enrolment reader

\* Ensure correct version when enrolling on software

## 4.2 Administrator Loss Prevention

To avoid the menu operation failure as a result of loss of administrator, you may take the following measures: Press and hold the Menu key for 3 seconds to display the administrator verification interface. Then move the band switch on the rear of the fingerprint lock to the left or right. Now you can access the menus as super administrator for management and operation.

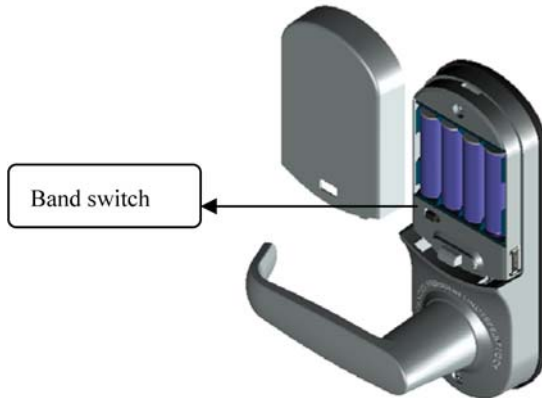

## 4.3 Battery Low Voltage

Low Voltage Protection: When the battery meter stays at one bar, the system prompts you to replace the battery and the battery icon starts flashing. If you press and hold the Menu key, the system prompts you that you cannot access menus. In addition, the menus are also inaccessible during use of external power so as to prevent data loss caused by power instability. When the battery meter stays less than one bar, the battery shuts itself off automatically.

## 4.4 Auto Program Exit / Power Off

The fingerprint lock powers off automatically upon successful matching and unlocking.

- The fingerprint lock powers off automatically when you set Yes for the "Normal Open" option upon unlocking.
- The fingerprint lock powers off automatically when the number of invalid operations exceeds the threshold. The fingerprint lock powers off automatically when an alarm is generated for 30 seconds upon restart.
- The fingerprint lock powers off automatically when the supply voltage is lower than level-3 detection voltage.
- The fingerprint lock powers off automatically if there is no keystroke within 10 seconds on the initial interface.

## Summary

\* Manual override on administrator

\* Take note of power-off settings

## 4.5 Unlock with Emergency Key

You can open the door using an emergency mechanical key in case the electronic-component does not operate.

- Try open the keyhole cover by inserting the sharp end of a ball-pen or screwdriver with a diameter of less than 3 mm. Remove the cover.
- Insert the emergency key into the keyhole and rotate 90° to unlock.



1. Remove the screw from the lock handle, and take off the handle.



2. Insert the key, turn to right or left 180° to unlock the door.

## Summary

\* Emergency Key provided to open in case of emergencies

## 5. Appendix

### 5.1 Technical Specifications

- Sensor: Optics sensor without coating
- Capacity: 500 fingerprint images; 100 passwords; 500 users.
- Matching mode: Fingerprint matching, password matching.
- Record capacity: 30000
- Resolution: 500 DPI
- Identification speed:  $\leq 2$  seconds
- False acceptance rate:  $\leq 0.0001\%$
- False rejection rate:  $\leq 1\%$
- Power: Four AA batteries; working voltage: 4.2V–6V.
- Locking count:  $\geq 4000$  (Four NANFU alkaline batteries)
- Temperature: -10–55°C
- Humidity: 10%–95%